

MADE IN ITALY

®

OMEF GROUP

FORESTRY EQUIPMENT MANUFACTURER

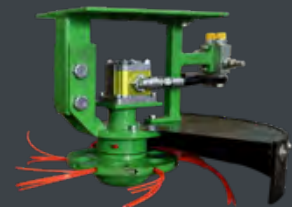
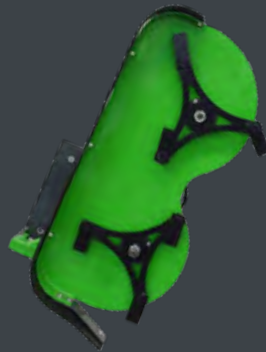

**SCAN the QR CODE and
WATCH the OMEF RANGE in ACTION!**



**SCANSIONA il QR CODE e
GUARDA la GAMMA OMEF in AZIONE!**

YOUR FORESTRY PARTNER SINCE 1991



OMEF-GROUP is a leading international company specializing in the production of equipment for the **forestry and landscape maintenance industry**.

Founded in 1991, it is present in more than **40 countries** with a network of official dealers.

OMEF products benefit from the prestigious quality of **MADE IN ITALY** products and are entirely manufactured in the production plant in Tagliolo Monferrato (ITALY).

Careful design and the best raw materials, guarantee the **highest quality standards** and maximum product durability even under the most extreme working conditions.

Get ready to discover the **OMEFamily**

IL TUO PARTNER NEL SETTORE FORESTALE dal 1991

OMEF-GROUP è un'azienda, leader a livello internazionale, specializzata nella produzione di attrezzature per il **settore forestale e manutenzione del verde**.

Fondata nel 1991, OMEF è presente in oltre **40 paesi** con una rete di rivenditori ufficiali.

I prodotti OMEF si avvalgono della prestigiosa qualità dei prodotti **MADE IN ITALY** e vengono interamente realizzati nello stabilimento produttivo di Tagliolo Monferrato (AL).

L'accurata progettazione e le migliori materie prime, garantiscono i più **elevati standard di qualità** e la massima durata dei prodotti anche nelle condizioni di lavoro più estreme.

Preparati a scoprire la

OMEFamily



Continuous research, continuous design, continuous improvement. We have never looked back, this is why we are your best choice in the forestry field.



Ricerca continua, progettazione, miglioramenti. Non ci siamo mai fermati, ecco perchè siamo la tua scelta migliore nel settore forestale.

PRODUCTION

PRODUZIONE



01.
RESEARCH
RICERCA



02.
DESIGN
PROGETTAZIONE



03.
CUTTING
TAGLIO



04.
ASSEMBLY
MONTAGGIO



05.
WELDING
SALDATURA



06.
TEST
COLLAUDO



07.
PAINTING
VERNICIATURA



08.
DELIVERY
CONSEGNA

FORESTRY DIVISION WOOD PROCESSING DIVISIONE FORESTALE LAVORAZIONE DEL LEGNO



TREE SHEAR PINZA CESCOIA



1

EXTENDED LEVER ARM

Increased cutting power. Felling and holding of the tree in a single action.

GANASCIA CON BRACCIO DI LEVA MAGGIORATO

Potenza di taglio aumentata. Abbattimento e trattenuta della pianta in un'unica azione.



4

HIGH-PERFORMANCE CYLINDER

Simplified control thanks to the use of a single hydraulic line.

CILINDRO AD ALTE PRESTAZIONI

Controllo semplificato grazie all'utilizzo di una sola linea idraulica.



3

REINFORCED STRUCTURE

Compactness, lightness, resistance and safety.

STRUTTURA RINFORZATA

Compattezza, leggerezza, resistenza e sicurezza.

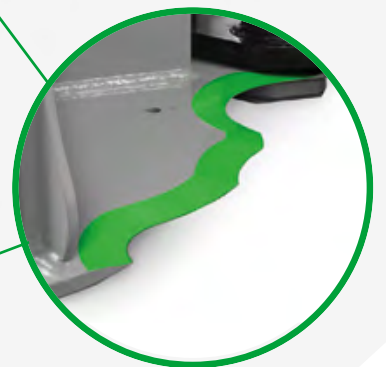

2

SHAPED BLADE

Profile shaped and tested to give better cutting efficiency on all types of wood.

LAMA SAGOMATA

Profilo sagomato e testato per conferire una migliore efficienza di taglio su ogni tipologia di legno.



WATCH IT IN ACTION
GUARDA IN AZIONE



FEATURES

- Perfect for felling trees and plants.
- Cutting and holding the plant in a single action.
- 1 "two-way flow" hydraulic circuit.
- Welded blade.
- Reinforced machine body.
- Low maintenance design.
- Supplied with adapter plate.

Upon request:

- custom-made mounting bracket;
- hoses;
- bolted blade available.

CARATTERISTICHE

- Ideale per l'abbattimento di tronchi e piante.
- Taglio e trattenuta della pianta in un'unica azione.
- 1 linea idraulica a doppio effetto.
- Lama saldata.
- Corpo macchina rinforzato.
- Progettata per una ridotta manutenzione.
- Fornita con piastra di adattamento.

Su richiesta:

- sella di attacco, disponibile su misura;
- fornitura di tubi;
- disponibile con lama imbullonata.

TECHNICAL INFORMATION

CARATTERISTICHE TECNICHE

	BI100	BI200	BI300	BI400	BI500	BI600
	1,5 - 3 tons	3 - 7 tons	8 - 14 tons	14 - 24 tons	23 - 30 tons	min. 30 tons
 KG	140 Kg 310 lbs	230 Kg 507 lbs	420 Kg 925 lbs	845 Kg 1862 lbs	1810 Kg 3990 lbs	2400 Kg 5291 lbs
 MIN	40 mm 1,5"	50 mm 2"	60 mm 2,5"	120 mm 2,5"	200 mm 8"	270 mm 11"
 MAX	150 mm 6"	200 mm 8"	300 mm 12"	400/450 mm 16" /18"	500/600 mm 20" /24"	600/700 mm 23" /27"
 min - max	180 - 220 bar 2610 - 3190 psi	180 - 250 bar 2610 - 3625 psi	180 - 280 bar 2610 - 4060 psi	250 - 300 bar 3625 - 4350 psi	300 - 350 bar 4350 - 5075 psi	320 - 400 bar 4640 - 5800 psi
 min - max	25 - 40 l/min 7 - 11 gal/min	30 - 80 l/min 8 - 21 gal/min	50 - 120 l/min 13 - 32 gal/min	100 - 180 l/min 26 - 48 gal/min	180 - 250 l/min 48 - 66 gal/min	250 - 300 l/min 66 - 80 gal/min
Larghezza Width	800 mm 31"	890 mm 35"	1115 mm 44"	1455 mm 57"	1640 mm 65"	1965 mm 77"
Lunghezza Lenght	775 mm 30"	1010 mm 39"	1240 mm 49"	1500 mm 59"	1860 mm 73"	2057 mm 81"
Altezza Height	420 mm 16"	462 mm 18"	552 mm 22"	707 mm 28"	892 mm 35"	1021 mm 40"
	☑	☑	☑	☑	☑	☑
	☑	☑	☑			
	☑	☑	☑			
		☑	☑	☑		
	☑	☑	☑			

☑ suitable - disponibile

"BIG INCH" RANGE
GAMMA "BIG INCH"

MADE IN ITALY
OMEF GROUP
FORESTRY EQUIPMENT MANUFACTURER



BI100



BI200



BI300

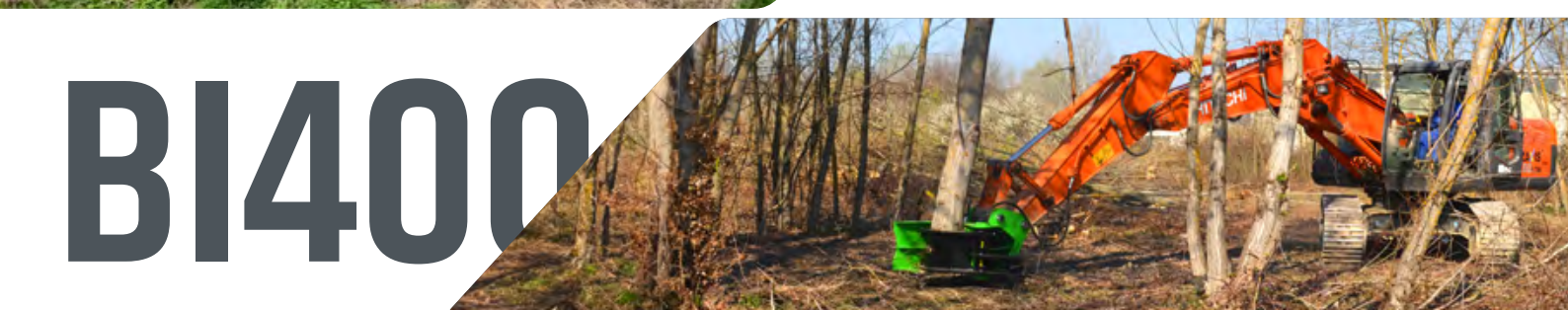

BI400



BI500



BI600

“BIG INCH” ACCESSORIES

ACCESSORI “BIG INCH”

MADE IN ITALY
OMEF GROUP
FORESTRY EQUIPMENT MANUFACTURER



HOLDER: designed for a better control during the cutting and handling phase of the tree.

SUPPORTO: ideato per un maggiore controllo durante la fase di taglio e di movimentazione della pianta.

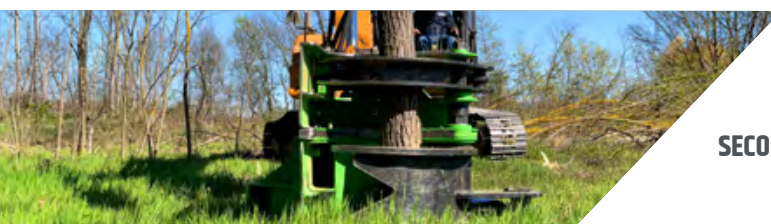

TILT ROTATOR: allows the shear to oscillate around the horizontal axis both clockwise and counterclockwise directions.

TILT ROTATOR: permette alla cesoia di oscillare sull'asse orizzontale in senso orario e antiorario.



RIPPER: designed to facilitate the movement of the machine in inaccessible areas and moving soil and small stumps.

RIPPER: progettato per agevolare il movimento della macchina operativa in zone impervie e smuovere il terreno e piccole ceppaie.

CRANE ADAPTER: designed for mounting the tree shear on crane.

ATTACCO PER GRU: progettato per l'installazione della pinza cesoia su gru.



360° ROTATION: allows 360° clockwise and counterclockwise rotation of the tree shear to better accommodate the cutting angle.

ROTAZIONE 360°: permette la rotazione della cesoia a 360° in senso orario e antiorario per adattarsi meglio all'inclinazione di taglio.



SUPPORT GRAB: designed to allow for greater safety in the retention of the plant particularly in urban areas.

PINZA DI SUPPORTO: progettata per consentire una maggior sicurezza nella trattenuta della pianta in particolare in zone urbane.

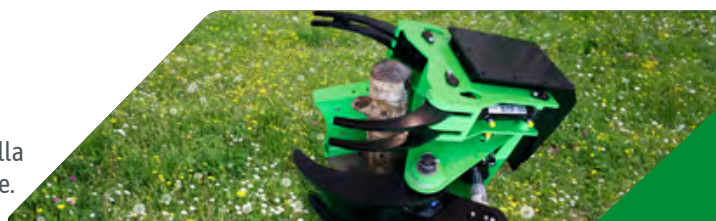

ACCESSORIES TECHNICAL INFORMATION

CARATTERISTICHE TECNICHE ACCESSORI

	BI100	BI200	BI300	BI400	BI500	BI600
 SECONDA PINZA GRAB ARM				☑ 300 kg 660 lbs	☑ 640 kg 1410 lbs	
 PINZA RACCOGLI-TRICE BUNCHER		☑ 80 kg 175 lbs	☑ 120 kg 265 lbs	☑ 215 kg 475 lbs		
 ROTAZIONE 360° ROTATION 360°	☑ 120 kg 265 lbs	☑ 300 kg 660 lbs	☑ 350 kg 770 lbs	☑ 500 kg 1100 lbs		
 TILT TILT		☑	☑ 300 kg 660 lbs	☑ 482 kg 1063 lbs	☑	
 SUPPORTO HOLDER				☑ 145 kg 320 lbs		
 RIPPER RIPPER			☑ 185 kg 410 lbs	☑ 230 kg 510 lbs		
 ATTACCO PER GRU CRANE ADAPTER	☑	☑ 130 kg 286 lbs	☑ 190 kg 418 lbs			
 PINZA AUSILIARIA SUPPORT GRAB			☑ 120 kg 265 lbs			

☑ suitable - disponibile

GS400

GRAPPLE SAW PINZA MOTOSEGA



WATCH IT IN ACTION
GUARDA IN AZIONE

FEATURES

- Developed for precision tree felling and pruning.
- It allows felling, sectioning, and moving trees them with the same machine.
- 2 hydraulic circuits:
 - a "one-way flow" to saw cassette;
 - a "two-way flow" to rotation and grapple with solenoid valve.
- Applicable on operating machines with fixed coupling.
- Made of wear-resistant steel.
- Safety lock valve on grapple hydraulic cylinder.
- Supplied with adapter plate.
- Inlet relief valve on saw cassette.
- Self-braking motor with lock valve on rotation unit.
- Automatic saw bar lubrication.
- Manual mechanical chain tensioner.

Upon request:

- custom-made mounting bracket;
- hoses.

CARATTERISTICHE

- Sviluppata per l'abbattimento di precisione di tronchi e rami.
- Consente di abbattere, sezionare i tronchi e movimentarli tutto con la stessa macchina.
- 2 linee idrauliche:
 - 1 per gruppo motosega a un effetto;
 - 1 per rotazione e pinza a doppio effetto, con elettrovalvola.
- Applicabile su macchine operatrici con attacco fisso.
- Realizzata in acciaio antiusura.
- Valvola di blocco su cilindro oleodinamico di sicurezza.
- Fornita con piastra di adattamento.
- Valvola di massima in ingresso su gruppo sega.
- Motore autofrenante con valvola di blocco su gruppo rotazione.
- Lubrificazione automatica barra sega.
- Tenditore catena meccanico manuale.

Su richiesta:









- sella di attacco, disponibile su misura;
- fornitura di tubi.

TECHNICAL INFORMATION

CARATTERISTICHE TECNICHE



GS400

	5 - 10 tons		220 - 250 bar 3190 - 3625 psi
	410 kg 904 lbs		30 - 60 l/min 8 - 16 gpm
	400 mm 16"		Motore a pistoni "Parker" 6 cc "Parker" piston motor 6 cc
CARICO MASSIMO/ MAXIMUM WORKLOAD	1500 kg 3305 lbs	CATENA SAW CHAIN	.404" 1,6 mm
APERTURA MASSIMA/ MAXIMUM OPENING	950 mm 35,5"		550 mm 21,6"
			360°

GRAPPLE SAW PINZA MOTOSEGA



FEATURES

- Developed for felling trees with large stems..
- Allows felling, sectioning and handling logs, with the same machine.
- 2 "two-way flow" hydraulic circuits.
- One 6-way solenoid valve 3/4" to switch the grapple into the saw bar line.
- 7 claws with 30 mm thickness and maximum grab opening of 2200 mm.
- Grab piston of 33 tons clamping force with block and pressure relief valve on cylinder.
- Inlet pressure relief valve on saw bar.
- Watertight rotation case.
- Gear transmission with Ø 700mm slewing ring.
- Clamp and frame constructed entirely in Hardox 400 steel.
- Drainage on precharged accumulator.
- Four 800cc orbital motors.

Upon request:

- mounting bracket, custom-made available;
- hoses.

CARATTERISTICHE

- Sviluppata per l'abbattimenti di piante ad alto fusto.
- Consente di abbattere, sezionare e movimentare tronchi di notevole diametro, con la stessa macchina.
- 2 linee idrauliche a doppio effetto.
- 1 elettrovalvola da 3/4 per commutare pinza in barra sega.
- Apertura pinza 2200 mm a 7 chele aperte con spessore 30 mm.
- Pistone pinza da 33 tons di forza serrante con valvola di blocco e massima sul cilindro.
- Valvola di massima pressione in ingresso sul gruppo sega.
- Cassa rotazione a tenuta stagna.
- Trasmissione a ingranaggi modulo 8 con ralla dentata Ø 700mm.
- Pinza e telaio costruito interamente in acciaio Hardox 400.
- Drenaggio su accumulatore precaricato.
- 4 motori orbitali da 800cc.

Su richiesta:

- sella di attacco, disponibile su misura;
- fornitura di tubi.

TECHNICAL INFORMATION

CARATTERISTICHE TECNICHE



GS800

	22 - 30 tons		PINZA + SEGA GRAPPLE + SAW	250 bar 3625 psi
	1650 kg 3638 lbs	min - max	ROTAZIONE ROTATION	200 bar 2900 psi
	800 mm		PINZA + SEGA GRAPPLE + SAW	160 l/min 42 gpm
CARICO MASSIMO/ MAXIMUM WORKLOAD	3000 kg 6614 lbs	min - max	ROTAZIONE ROTATION	70 l/min 18 gpm
APERTURA MASSIMA/ MAXIMUM OPENING	2200 mm 87"		Motore a pistoni "Parker" 30 cc "Parker" piston motor 30 cc	
	360°	CATENA SAW CHAIN		3/4"
				1050 mm 41"

PTH900

GRAPPLE SAW PINZA MOTOSEGA



WATCH IT IN ACTION
GUARDA IN AZIONE

FEATURES

- It allows the handling and sectioning of even very large logs.
- 3 hydraulic circuits:
 - a "one-way flow" to saw cassette;
 - a "two-way flow" to grapple;
 - a "two-way flow" to rotator;
- Made of wear-resistant steel.
- Safety lock valve on grapple hydraulic cylinder.
- Grapple opening over 2 meters.
- Integrated pressure relief valve.
- Grapple with double cylinder.
- Automatic saw bar lubrication.
- Manual mechanical chain tensioner.

Upon request:

- custom-made mounting bracket;
- hoses.

CARATTERISTICHE

- Permette di movimentare e sezionare tronchi anche di notevoli dimensioni.
- 3 linee idrauliche:
 - 1 per gruppo motosega a un effetto;
 - 1 per pinza a doppio effetto;
 - 1 per rotore a doppio effetto.
- Realizzata in acciaio antiusura.
- Valvola di blocco di sicurezza su cilindro oleodinamico della pinza.
- Apertura pinza oltre i 2 metri.
- Valvola di massima pressione integrata.
- Pinza con doppio cilindro.
- Lubrificazione automatica barra sega.
- Tenditore catena meccanico manuale.

Su richiesta:

- sella di attacco, disponibile su misura;
- fornitura di tubi.

TECHNICAL INFORMATION

CARATTERISTICHE TECNICHE

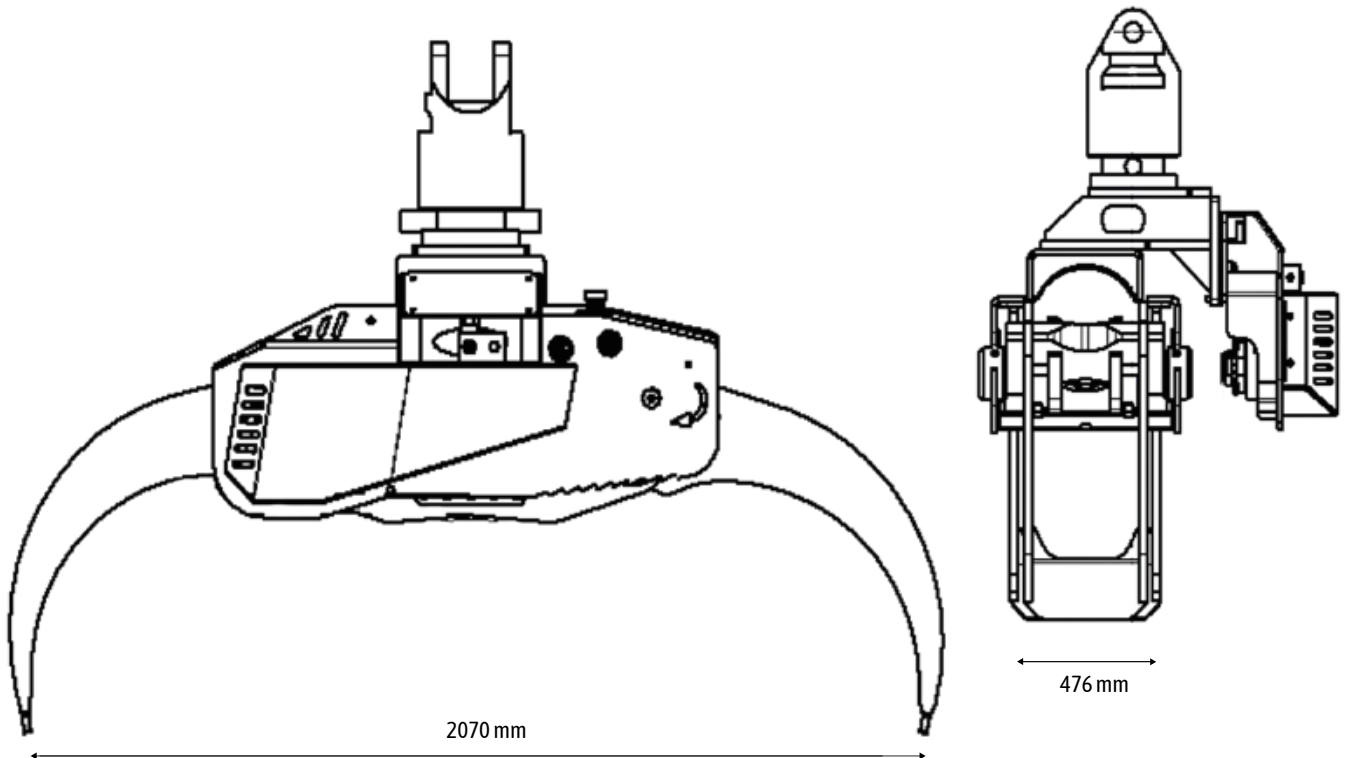

PTH900

	12 - 18 tons	CARICO MASSIMO / MAXIMUM WORKLOAD	5000 kg 11025 lbs
	590 kg 1300 lbs	APERTURA MASSIMA / MAXIMUM OPENING	2070 mm 81"
	900 mm 35"		Motore a pistoni 30 cc Piston motor 30 cc
	PINZA GRAPPLE 180 - 230 bar 2610 - 3336 psi		Carico assiale dinamico massimo +80 kN Max. axial load dynamic +17988 lbf
	SEGA SAW 250 bar 3627 psi		CATENA SAW CHAIN
	ROTOR ROTORE 250 bar 3627 psi		3/4"
	PINZA GRAPPLE 70 l/min 18 gpm		1000 mm
	SEGA SAW 130 - 160 l/min 18 gpm		
	ROTOR ROTORE 40 l/min 10 gpm		

FORESTRY PRUNER POTATRICE FORESTALE



WATCH IT IN ACTION
GUARDA IN AZIONE

FEATURES

- Dedicated to precision pruning.
- Suitable for all plants from small to large trunk.
- 2 “two-way flow” hydraulic circuits.
- High wear-resistant blade.
- 360° rotation system included.
- Available for mounting on skid steer, backhoe loaders and telehandlers only for CS100 and CS200 models.

Upon request:

- custom-made mounting bracket;
- hoses.

CARATTERISTICHE

- Perfetta per la potatura di precisione.
- Adatta per tutte le piante da piccolo ad ampio fusto.
- 2 linee idrauliche a doppio effetto.
- Lama ad alta resistenza antiusura.
- Sistema di rotazione 360° incluso.
- Disponibile per il montaggio su skid steer, terne e sollevatori telescopici solo nei modelli CS100 e CS200.

Su richiesta:

- sella di attacco, disponibile su misura;
- fornitura di tubi.

TECHNICAL INFORMATION

CARATTERISTICHE TECNICHE



MADE IN ITALY
OMEF GROUP
 FORESTRY EQUIPMENT MANUFACTURER



CS100



1,6 - 3,5 tons

120 Kg
265 lbs

100 mm
4"

180 - 250 bar
2610 - 3625 psi

20 - 45 l/min
5 - 12 gpm

360°

CS200



3,5 - 6 tons

210 Kg
460 lbs

200 mm
8"

180 - 250 bar
2610 - 3625 psi

30 - 60 l/min
8 - 16 gpm

360°

CS300



6 - 10 tons

340 Kg
750 lbs

300 mm
12"

180 - 250 bar
2610 - 3625 psi

40 - 80 l/min
10 - 21 gpm

360°

CS400



10 - 24 tons

550 Kg
1212 lbs

400 mm
16"

200 - 250 bar
2900 - 3625 psi

50 - 100 l/min
13 - 26 gpm

360°

CS400H



12 - 24 tons

570 Kg
1260 lbs

420 mm
16,5"

200 - 250 bar
2900 - 3625 psi

50 - 100 l/min
13 - 26 gpm

360°



STUMP SHEAR ESTIRPACEPPI



WATCH IT IN ACTION
GUARDA IN AZIONE

FEATURES

- Designed to remove, chop and handle stumps in a single operation.
- Used in large-scale reclamation processes.
- Perfect for biomass production and the preparation of new plantations.
- 1 "two-way flow" hydraulic circuit.
- Body and blade designed to ensure gentle root removal without loosening the soil.
- Facilitates shredding even on the most fibrous stumps.

Upon request:

- custom-made mounting bracket;
- hoses.

CARATTERISTICHE

- Creata per rimuovere, sminuzzare e movimentare la ceppaia in un'unica operazione.
- Utilizzata nei processi di bonifica dei terreni su larga scala.
- Perfetta per la produzione di biomassa e per la preparazione di nuove piantagioni.
- 1 linea idraulica a doppio effetto.
- Corpo della struttura e lama progettate per garantire la rimozione delicata della radice senza lasciare dislivelli.
- Favorisce la triturazione anche dei ceppi più fibrosi

Su richiesta:

- sella di attacco, disponibile su misura;
- fornitura di tubi.

TECHNICAL INFORMATION

CARATTERISTICHE TECNICHE



	ST90	ST140
	14 - 20 tons	20 - 35 tons
	1600 Kg 3530 lbs	2500 Kg 5550 lbs
	900 mm 35"	1400 mm 55"
 min - max	250 - 300 bar 3625 - 4351 psi	280 - 320 bar 4061 - 4641 psi
 min - max	120 - 180 l/min 31 - 47 gpm	180 - 250 l/min 47 - 66 gpm
	70 tons	90 tons
A	1226 mm 48"	1431 mm 56"
B	2175 mm 85"	2480mm 97"
C	600 mm 23"	750 mm 30"

WOOD SPLITTER SPACCALEGNA



WATCH IT IN ACTION
GUARDA IN AZIONE

FEATURES

- Made for splitting and sectioning small or big logs.
- Useful for speeding up loading, chipping and mulching operations.
- Standard screw cone supplied with 2 or 4 threads.
- 1 "two-way flow" hydraulic circuit + 1 case drain line.
- Orbital motor with planetary gearbox.
- 40 - 60 screw revolutions per minute.
- Supplied with adapter plate.
- Accessory applications available for various uses.

Upon request:

- custom-made mounting bracket;
- hoses;
- stump planer (available for SPV2 510 - SPV2 810 - SPV3);
- auger drill.

CARATTERISTICHE

- Realizzata per spaccare e sezionare tronchi di piccole o grandi dimensioni.
- Utile per velocizzare operazioni di carico, cippatura e triturazione.
- Modello di serie in dotazione con punte a 2 o 4 principi.
- 1 linea idraulica a doppio effetto + 1 tubo di drenaggio.
- Motore orbitale con riduttore.
- 40 - 60 giri della vite al minuto.
- Fornita di piastra di adattamento.
- Disponibili punte accessorie per diversi utilizzi.

Su richiesta:

- sella di attacco, disponibile su misura;
- fornitura di tubi;
- fresaceppi (disponibile per SPV2 510 - SPV2 810 - SPV3);
- punta trivella.

TECHNICAL INFORMATION

CARATTERISTICHE TECNICHE



MADE IN ITALY
OMEF GROUP
 FORESTRY EQUIPMENT MANUFACTURER

	SPV1	SPV2			SPV3
		210	510	810	
					
	1,5 - 3,5 tons	3,5 - 5 tons	5,5 - 8 tons	8 - 14 tons	14 - 25 tons
	100 Kg 220 lbs	150 Kg 330 lbs	285 Kg 630 lbs	497 Kg 1110 lbs	770 Kg 1700 lbs
	50 cm 20"	70 cm 28"	100 cm 39"	150 cm 59"	200 cm 79"
	150 - 180 bar 2175 - 2610 psi	180 - 220 bar 2610 - 3190 psi	220 - 250 bar 3190 - 3625 psi	250 - 280 bar 3625 - 4061 psi	250 - 300 bar 3625 - 4351 psi
	30 - 60 l/min 8 - 15 gpm	40 - 60 l/min 10 - 15 gpm	75 - 100 l/min 20 - 26 gpm	100 - 200 l/min 26 - 53 gpm	150 - 200 l/min 40 - 53 gpm
	1520 Nm 1120 ft lbf	2480 Nm 1830 ft lbf	6440 Nm 4750 ft lbf	11560 Nm 8530 ft lbf	20000 Nm 14750ft lbf
	50 mm	50 mm	70 mm	100 mm	Flangiato Flanged connection
	2 principi 2 principles 170 mm 7"	4 principi 4 principles 200 mm 8"	4 principi 4 principles 250 mm 10"	4 principi 4 principles 300 mm 12"	4 principi 4 principles 400 mm 16"

ACCESSORIES

ACCESSORI



STUMP PLANER
 available for: SPV2 510 - SPV2 810 - SPV3

FRESACEPPI disponibile per: SPV2 510 - SPV2 810 - SPV3

250mm	350mm	550mm
10"	14"	22"



AUGER DRILL
TRIVELLA

150mm	200mm	300mm	400mm
6"	8"	12"	16"
500mm			
20"			

STUMP GRINDER FRESACEPPI



FEATURES

- Made for crushing stumps of woody stems of various diameters.
- 1 "one-way flow" hydraulic circuit + case drain line.
- Piston motor.
- 18 interchangeable teeth, arranged in a V shape.
- Mechanically modular protective covers with chains.
- Maximum pressure valve anti-shock and anti-cavitation.

Upon request:

- mounting bracket, custom-made available;
- hoses.

CARATTERISTICHE

- Realizzato per frantumare ceppaie di fusti legnosi di vario diametro.
- 1 linea idraulica a semplice effetto (martello) + tubo di drenaggio.
- Motore a pistoni.
- 18 denti intercambiabili, disposti a V.
- Carter di protezione, con catene, modulari meccanicamente.
- Valvola di massima pressione anti-shock e anti-cavitazione.

Su richiesta:

- sella di attacco, disponibile su misura;
- fornitura di tubi.

TECHNICAL INFORMATION
CARATTERISTICHE TECNICHE



FRS350

	2,5 - 6 tons	PROFONDITÀ DI LAVORO/ WORKING DEPTH DIAMETRO DISCO/ DISC DIAMETER 	100 mm 4"
	150 kg 330 lbs		400 mm 16"
	180 - 250 bar 2610 - 3625 psi		Motore a pistoni 17-25 cc/giro Piston Motor 17-25 cc/rev
	30 -60 l/min 8 - 16 gpm		

WOOD PROCESSOR PROCESSORE PER LEGNA



WATCH IT IN ACTION
GUARDA IN AZIONE

FEATURES

- Designed for cutting and splitting trunks in complete autonomy.
- Whole trunk loading until 3 m of length.
- Adjustable log splitting length from 20 to 60 cm.
- Adjustable 2/4-way splitting wedge.
- 1 "two-way flow" hydraulic circuit + 1 case drain line and 12 V line.
- 2 m cutting bench.
- Automatic lubrication system.
- Oil flow regulators for splitting device and saw bar.
- 12 V control joystick included.

Upon request:

- custom-made mounting bracket;
- hoses.

CARATTERISTICHE

- Ideato per il taglio e lo spacco di tronchi in totale autonomia.
- Carico dell'intero tronco fino a 3 m di lunghezza.
- Lunghezza di sezionamento del tronco da 20 a 60 cm.
- Spacco del ceppo in 2 o 4 pezzi.
- 1 linea idraulica a semplice effetto (martello) con drenaggio e 12 V.
- Lunghezza banco di taglio 2 m.
- Impianto di lubrificazione automatica.
- Regolatori di flusso per slitta e barra sega
- Joystick di comando da 12V in dotazione.

Su richiesta:

- sella di attacco, disponibile su misura;
- fornitura di tubi;

TECHNICAL INFORMATION

CARATTERISTICHE TECNICHE



Right splitting system.
 Sistema di spacco a destra.



Left splitting system.
 Sistema di spacco a sinistra.



Control joystick (12V)
 Joystick di comando (12V)

TS400

	5 - 12 tons		MAX	400 mm 16"
	> 100 HP		CATENA SAW CHAIN	.404" 1,6 mm
	50 - 90 HP			16 tons
	550 kg 1213 lbs			12V
	180 - 200 bar 2610 - 2900 psi		ALTEZZA HEIGHT	1400 mm 550 lbs
	40 - 80 l/min 11 - 21 gpm		LUNGHEZZA WIDTH	2300 mm 905 lbs
			LARGHEZZA LENGHT	1500 mm 590 lbs

SPT620

LOG SPLITTER SPACCATRONCHI



FEATURES

- Made for splitting logs up to 60 cm of diameter.
- Thanks to its “grapple” design, it can also be used for loading and unloading timber.
- 1 “two-way flow” hydraulic circuit.
- Equipped with extractors.
- Equipped with adapter plate.
- Reinforced frame body for maximum strength.

Upon request:

- custom-made mounting bracket;
- hoses;
- swinging and fixed rotors available, to facilitate maneuvering and speed up work operations.

CARATTERISTICHE

- Realizzato per rompere tronchi fino a 60 cm di diametro.
- Grazie al suo design la pinza è utilizzabile anche per le operazioni di carico e scarico del legname .
- 1 linea idraulica a doppio effetto.
- Dotato di estrattori.
- Fornito di piastra di adattamento.
- Corpo della struttura rinforzato per la massima resistenza.

Su richiesta:

- sella di attacco, disponibile su misura;
- fornitura di tubi;
- disponibili rotori oscillanti e fissi, per agevolare le manovre e velocizzare le operazioni di lavoro.

TECHNICAL INFORMATION

CARATTERISTICHE TECNICHE



MADE IN ITALY
OMEF GROUP
 FORESTRY EQUIPMENT MANUFACTURER

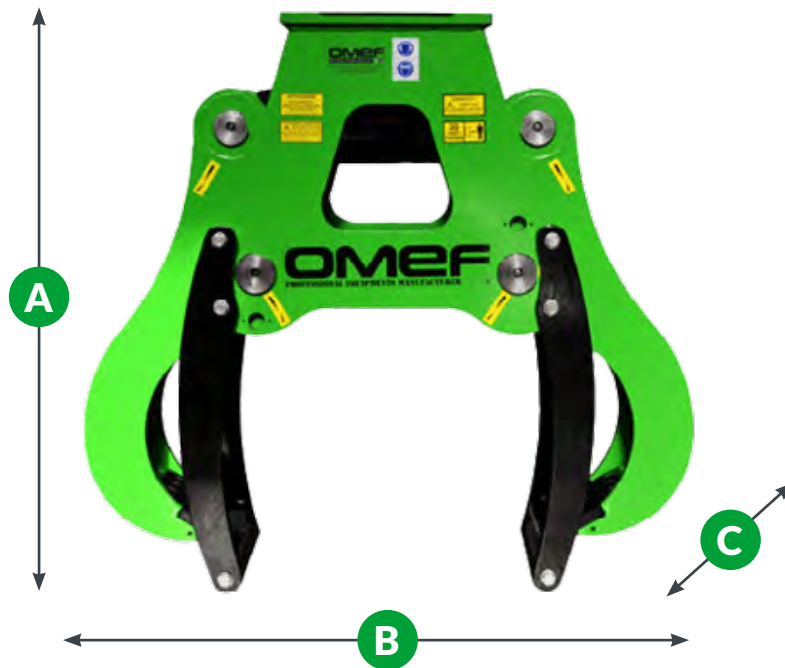

SPT620

	5 - 12 tons		33 tons
	350 kg 770 lbs		600 mm 24"
	200 - 250 bar 2900 - 3625 psi	A	1110 mm 44"
	40 - 80 l/min 11 - 21 gpm	B	1120 mm 44"
		C	350 mm 14"

ACCESSORIES

ACCESSORI



360° ROTATION SWINGING
 ROTAZIONE 360° OSCILLANTE



360° ROTATION FIXED
 ROTAZIONE 360° FISSA

LOG GRAPPLE PINZA FORESTALE



FEATURES

- Designed to collect, pick and move trunks of every sizes.
- 1 "two-way flow" hydraulic circuit.
- Integrated lock and relief valve on all grapples.
- * Available with open or closed tips.
- The "R" series is manufactured with side reinforcements along all claws.
- The 'HD' series, in addition to the side reinforcements along the claws, also features a double-frame design.

Upon request:

- custom-made mounting bracket;
- hoses;
- swinging and fixed rotors available, to facilitate maneuvering and speed up work operations.

CARATTERISTICHE

- Creata per raccogliere, selezionare e spostare tronchi e legname di ogni dimensione.
- 1 linea idraulica a doppio effetto.
- Valvola di blocco e di massima integrata su tutte le pinze.
- * Disponibile con punte aperte o con punte chiuse.
- La serie "R" è realizzata con rinforzi laterali lungo tutte le chele.
- La serie "HD" oltre i rinforzi laterali lungo le chele presenta anche una struttura con doppia scatola.

Su richiesta:

- sella di attacco, disponibile su misura;
- fornitura di tubi;
- disponibili rotori oscillanti e fissi, per velocizzare le operazioni di lavoro.

TECHNICAL INFORMATION

CARATTERISTICHE TECNICHE



MADE IN ITALY
OMEF GROUP
 FORESTRY EQUIPMENT MANUFACTURER

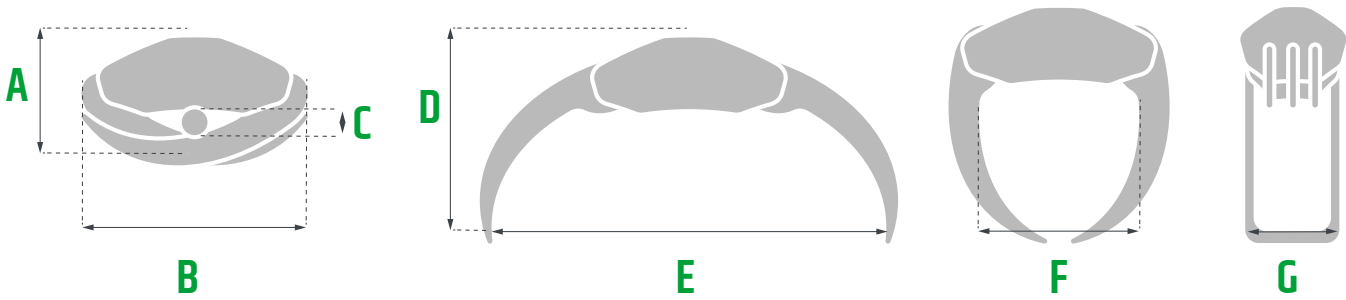

PFIMX

	1000R	1300R	1500R	1400HD	1600HD	1800HD
	1,5 - 2 tons	2 - 3 tons	3 - 5 tons	4 - 7 tons	6 - 9 tons	8 - 13 tons
CAPACITÀ CAPACITY	0,15 M ³	0,20 M ³	0,30 M ³	0,20 M ³	0,30 M ³	0,40 M ³
PORTATA LOAD	800 kg 1763 lbs	1500 kg 3306 lbs	2500 kg 5511 lbs	2000 kg 4409 lbs	3000 kg 6613 lbs	4000 kg 8818 lbs
	70 kg 154 lbs	118 kg 260 lbs	138 kg 304 lbs	124 kg 273 lbs	228 kg 503 lbs	260 kg 573 lbs
	MAX 200 bar 2900,75 psi	MAX 200 bar 2900,75 psi	MAX 200 bar 2900,75 psi	MAX 200 bar 2900,75 psi	MAX 200 bar 2900,75 psi	MAX 200 bar 2900,75 psi
A	420 mm	490 mm	590 mm	540 mm	590 mm	660 mm
B	591 mm	750 mm	860 mm	740 mm	875 mm	1020 mm
C	55 mm	120 mm	130 mm	90 mm	120 mm	100 mm
D	595 mm	670 mm	825 mm	630 mm	780 mm	840 mm
E	1000 mm	1350 mm	1510 mm	1435 mm	1570 mm	1950 mm
F	430 mm	580 mm	680 mm	540 mm	630 mm	700 mm
G	375 mm	440 mm	490 mm	370 mm	400 mm	480 mm

ACCESSORIES

ACCESSORI



360° ROTATION SWINGING
 ROTAZIONE 360° OSCILLANTE



360° ROTATION FIXED
 ROTAZIONE 360° FISSA



MADE IN ITALY
OMEF GROUP
FORESTRY EQUIPMENT MANUFACTURER

**MULCHING
LAND CLEARING
TRINCIATURA
MANUTENZIONE DEL SUOLO**



MULCHING - LAND CLEARING | TRINCIATURA - MANUTENZIONE DEL SUOLO

TRL68

BRUSH CUTTER TRINCIATRICE A LAME



WATCH IT IN ACTION
GUARDA IN AZIONE

FEATURES

- Designed for mowing grass, bushes and shredding small logs.
- Lightweight and extremely versatile design.
- 1 "one-way flow" hydraulic circuit + 1 case drain line.
- Powerful piston motor.
- 2 wear-resistant blades.

Upon request:

- custom-made mounting bracket;
- hoses;
- chains to replace cutting blades.

CARATTERISTICHE

- Progettata per rasare erba, arbusti e trinciare piccoli tronchi.
- Struttura leggera ed estremamente versatile.
- 1 linea idraulica a semplice effetto (martello) + drenaggio.
- Potente motore a pistoni.
- 2 lame antiusura.

Su richiesta:

- sella di attacco, disponibile su misura;
- fornitura di tubi;
- catene in sostituzione delle lame da taglio.

TECHNICAL INFORMATION

CARATTERISTICHE TECNICHE



MADE IN ITALY
OMEF GROUP
 FORESTRY EQUIPMENT MANUFACTURER

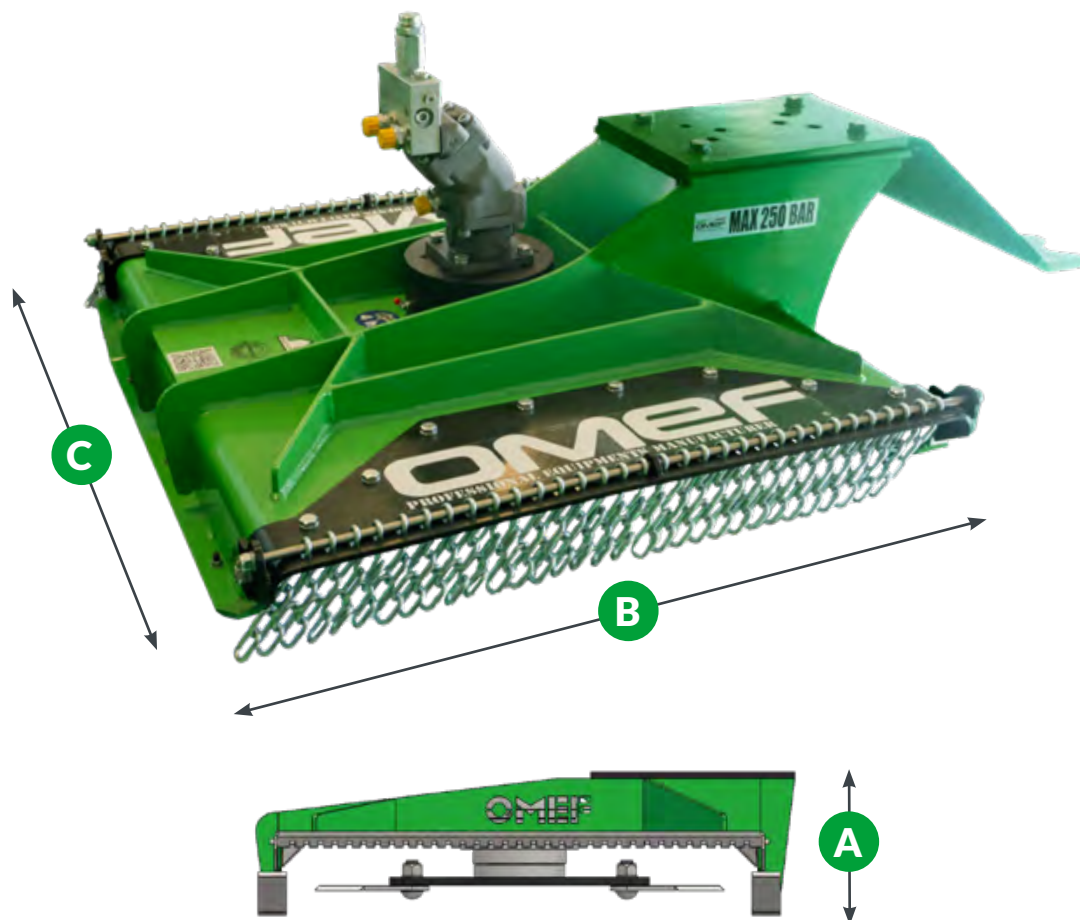

TRL68

	5 - 9 tons		50 mm 2"
	185 kg 410 lbs	MAX	
	220 - 250 bar 3190 - 3625 psi	SUPERFICIE DI TAGLIO CUT WIDTH	700 mm 27"
	60 - 80 l/min 15 - 21 gpm	A	275 mm 11"
		B	980 mm 38"
		C	920 mm 36"

TE1

HYDRAULIC MULCHER TRINCIATRICE IDRAULICA

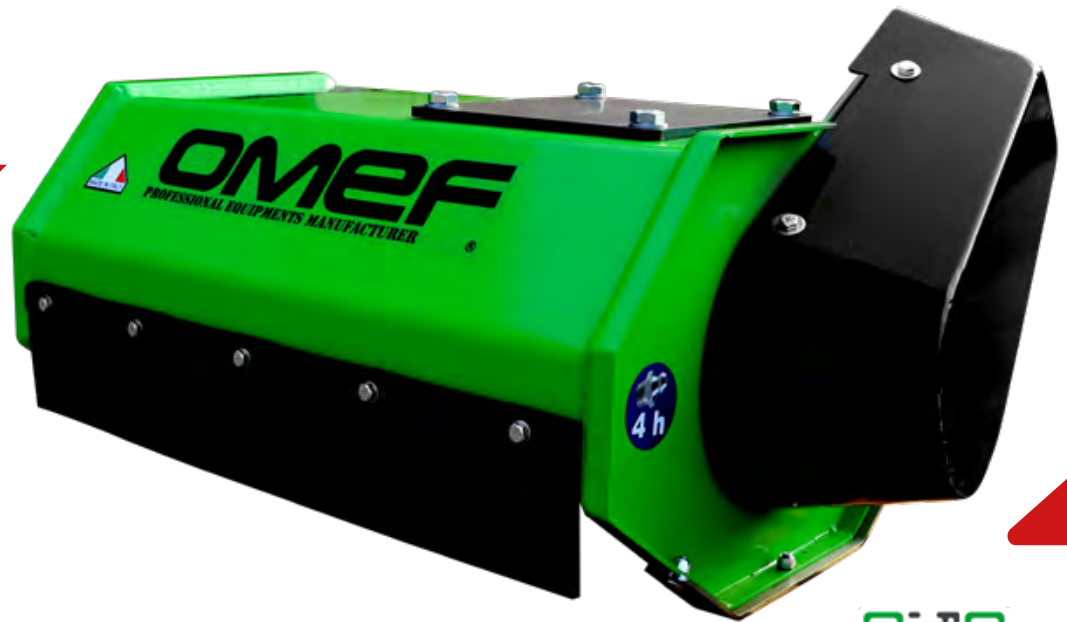

WATCH IT IN ACTION
GUARDA IN AZIONE

FEATURES

- Mulcher designed for cleaning grass and shrubs.
- Direct transmission.
- Symmetrical shearing head for quick excavator rotation.
- Protective cover for motor.
- Valves block complete with priority valve for adjusting oil flow, anti-shock valve (pressure relief valve), anti-cavitation and self-draining.
- "Casappa" aluminium group 2 gear motor.
- Accident prevention rubber protections according to EC directives

Upon request:

- custom-made mounting bracket;
- hoses.

CARATTERISTICHE

- Trinciatrice progettata per la pulizia di erba e piccoli arbusti.
- Trasmissione diretta.
- Trinciatrice simmetrica per un taglio più veloce con la rotazione dell'escavatore.
- Protezione carter motore.
- Blocco valvole comprensivo di valvola prioritaria per regolazione della portata olio, antiurto (valvola di max pressione), anticavitazione e autodrenante.
- Motore gruppo 2 in alluminio "Casappa".
- Protezioni antinfortunistiche in gomma a norma CE.

Su richiesta:

- sella di attacco, disponibile su misura;
- fornitura di tubi.

TECHNICAL INFORMATION

CARATTERISTICHE TECNICHE



Rotor
 Rotore

K/M



MAZHF1
 Ø max 3 cm



CLTKF1
 Ø max 2 cm



MODELLO MODEL	tons	cm/inch	LxHxH cm/inch	KG kg/lbs	CILINDRATA MOTORE ENGINE DISPLACEMENT	OIL l/min - gpm	bar - psi (min-max)		
TE1.1-60K/M	1 - 3	60 24	85x50x35 34x20x14	70 154	8 - 11	20-30 6-8	170-220 2500-3200	direct diretta	12
TE2.1-80K/M	2 - 3	80 32	100x50x35 40x20x14	80 176	8 - 11	30-40 8-11	170-220 2500-3200	direct diretta	16

Hydraulic gear motor range
 Scelta motore idraulico a ingranaggi

ton	1 - 2	2 - 3
CILINDRATA MOTORE ENGINE DISPLACEMENT cc	8	11
l/min gpm	20 6	30 8

HYDRAULIC MULCHER TRINCIATRICE IDRAULICA

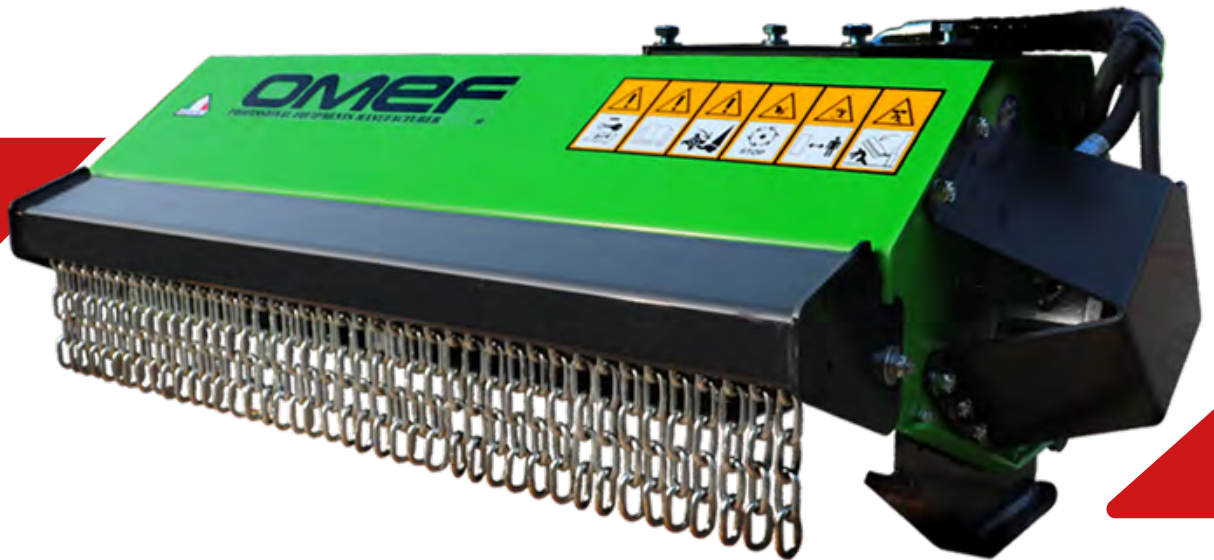

WATCH IT IN ACTION
GUARDA IN AZIONE

FEATURES

- Mulcher designed for cleaning grass and shrubs.
- Feeler roller adjustable on 3 positions to change the height of the cut.
- Helicoidal rotor with tempered hammers or interchangeable blades.
- Protective cover for motor.
- Valves block complete with priority valve for adjusting oil flow, anti-shock valve (pressure relief valve), anti-cavitation and self-draining.
- "Casappa" aluminium group 2 gear motor.
- Accident prevention rubber protections according to EC directives

Upon request:

- custom-made mounting bracket;
- hoses.

CARATTERISTICHE

- Trinciatrice progettata per la pulizia di erba e arbusti.
- Rullo di appoggio regolabile su 3 posizioni per variare l'altezza di taglio
- Rotore elicoidale con mazze bonificate o coltelli intercambiabili.
- Protezione carter motore.
- Blocco valvole comprensivo di valvola prioritaria per regolazione della portata olio, antiurto (valvola di max pressione), anticavitazione e autodrenante.
- Motore gruppo 2 in alluminio "Casappa".
- Protezioni antinfortunistiche in gomma a norma CE.

Su richiesta:

- sella di attacco, disponibile su misura;
- fornitura di tubi.

TECHNICAL INFORMATION

CARATTERISTICHE TECNICHE



Rotor Rotore

K/M





MAZHF2
 Ø max 5 cm





CLTKC1
 Ø max 3 cm



MODELLO MODEL	 tons	 cm/inch	 LxAxH cm/inch	 kg/lbs	CILINDRATA MOTORE ENGINE DISPLACEMENT	 l/min - gpm	 bar - psi (min-max)		
TE1.3-70K/M	1,5 - 5	70 28	95x55x45 38x22x18	130 287	8 - 11 - 16	20-30-40 6-8-11	170-220 2500-3200	direct diretta	10
TE2.3-90K/M	2 - 5	90 36	115x55x45 46x22x18	150 331	11 - 16	30-40 8-11	170-220 2500-3200	direct diretta	14

Hydraulic gear motor range
 Scelta motore idraulico a ingranaggi

 ton	1,5 - 2	2 - 3,5	3,5 - 5
CILINDRATA MOTORE ENGINE DISPLACEMENT cc	8	11	16
 l/min gpm	20 6	30 8	40 11

HYDRAULIC MULCHER TRINCIATRICE IDRAULICA



WATCH IT IN ACTION
GUARDA IN AZIONE

FEATURES

- Mulcher designed for cleaning grass and shrubs over large areas.
- Direct transmission.
- Feeler roller adjustable on 3 positions to change the height of the cut.
- Helicoidal rotor with austempered hammers or interchangeable blade .
- Protective cover for motor.
- Valves block complete with priority valve for adjusting oil flow, anti-shock valve (pressure relief valve), anti-cavitation and self-draining.
- “Casappa” aluminium group 3 gear motor.
- Accident prevention rubber protections according to EC directives

Upon request:

- custom-made mounting bracket;
- hoses.

CARATTERISTICHE

- Trinciatrice progettata per la pulizia di erba e arbusti su ampie superfici.
- Trasmissione diretta.
- Rullo di appoggio regolabile su 3 posizioni per variare l'altezza di taglio.
- Rotore elicoidale con mazze bonificate o coltelli intercambiabili.
- Protezione carter motore.
- Blocco valvole comprensivo di valvola prioritaria per regolazione della portata olio, antiurto (valvola di max pressione), anticavitazione e autodrenante.
- Motore gruppo 3 in ghisa “Casappa”.
- Protezioni antinfortunistiche in gomma a norma CE.

Su richiesta:

- sella di attacco, disponibile su misura;
- fornitura di tubi.

TECHNICAL INFORMATION
CARATTERISTICHE TECNICHE



Rotor
Rotore

K/M











MAZHF3
Ø max 8 cm





CLTKF3
Ø max 6 cm



MODELLO MODEL	 tons	 cm/inch	 LxAxH cm/inch	 kg/lbs	CILINDRATA MOTORE ENGINE DISPLACEMENT	 l/min - gpm	 bar - psi (min-max)		
TE1.7-125K/M	5 - 8	125 50	145x75x50 58x30x20	250 551	22 - 27 - 34	60-70-80 16-19-22	200-220 2900-3200	direct diretta	20

Hydraulic gear motor range
Scelta motore idraulico a ingranaggi

 ton	5 - 7	7 - 8	8 - 9
CILINDRATA MOTORE ENGINE DISPLACEMENT cc	22	27	34
 l/min gpm	60 16	70 19	80 22

HYDRAULIC MULCHER TRINCIATRICE IDRAULICA



WATCH IT IN ACTION
GUARDA IN AZIONE

FEATURES

- Powerful and versatile mulcher suitable for cleaning shrubs and plants.
- K/M helical forestal rotor with 360° rotating hammers.
- MSFS swinging hammer flail mulcher with 360° rotating hammers.
- DF fixed teeth forestry mulcher.
- 3 toothed high-performance V-belts transmission.
- Internally reinforced double-case body
- Protective belts cover.
- Symmetrical shearing head for quick excavator rotation.
- Adjustable hood, fully openable for higher cutting capacity.
- Valves block complete with priority valve for adjusting oil flow, anti-shock valve (pressure relief valve), anti-cavitation and self-draining.
- "Casappa" group 3 cast iron gear motor.
- Accident prevention rubber protections according to EC directives.

Upon request:

- custom-made mounting bracket;
- hoses.

CARATTERISTICHE

- Trinciatrice progettata per la pulizia di erba e arbusti su ampie superfici.
- K/M rotore a mazze elicoidale con mazze bonificate e coltelli intercambiabili.
- MSFS rotore a mazze rotanti a scomparsa.
- DF rotore forestale a denti fissi.
- Trasmissione a 3 cinghie trapezoidali dentate.
- Cofanatura interna.
- Protezione carter cinghie.
- Trinciatrice simmetrica con bocche d'ingresso identiche in entrata e in uscita.
- Frontalini porta catene di protezione regolabili in altezza.
- Blocco valvole comprensivo di valvola prioritaria per regolazione della portata olio, antiurto (valvola di max pressione), anticavitazione e autodrenante.
- Motore gruppo 3 in ghisa "Casappa".
- Protezioni antinfortunistiche in gomma a norma CE.

Su richiesta:

- sella di attacco, disponibile su misura;
- fornitura di tubi.

TECHNICAL INFORMATION

CARATTERISTICHE TECNICHE



Cast iron hydraulic gear motor range
Scelta motore idraulico a ingranaggi

ton	3 - 4	5 - 6	6 - 7	7 - 8	8 - 10	10 - 12
CILINDRATA MOTORE ENGINE DISPLACEMENT	16	22	27	34	43	51
l/min gpm	30 8	40 11	50 14	60 16	80 22	100 28

Rotor Rotore

K/M



MAZHF3
Ø max 8 cm



CLTKF3
Ø max 6 cm



MODELLO MODEL	tons	cm/inch	LxAxH cm/inch	KG kg/lbs	CILINDRATA MOTORE ENGINE DISPLACEMENT	l/min - gpm	bar - psi (min-max)		
TE1.9-70K/M	3 - 5	70 28	85x80x60 34x32x24	180 397	16	30 8	170-220 2500-3200	3	10
TE2.9-90K/M	4,5 - 8	90 36	105x80x60 42x32x24	260 573	22 - 27 - 34	40-50-60 11-14-16	170-220 2500-3200	3	14

Rotor Rotore

MSFS



MAZHF17
Ø max 12 cm



MODELLO MODEL	tons	cm/inch	LxAxH cm/inch	KG kg/lbs	CILINDRATA MOTORE ENGINE DISPLACEMENT	l/min - gpm	bar - psi (min-max)		
TE1.9-70MSFS	5 - 8	70 28	85x80x60 34x32x24	290 640	22-27-34- 44-51	40-50-60- 80-100 11-14-16- 22-28	200-220 2900-3200	3	12
TE2.9-90MSFS	6 - 8	90 36	105x80x60 42x32x24	360 792	22-27-34- 43-51	40-50-60- 80-100 11-14-16- 22-28	200-220 2900-3200	3	18

Rotor Rotore

DF



DFHF14P
Ø max 25 cm



DFHF15
Ø max 20 cm



MODELLO MODEL	tons	cm/inch	LxAxH cm/inch	KG kg/lbs	CILINDRATA MOTORE ENGINE DISPLACEMENT	l/min - gpm	bar - psi (min-max)		
TE1.9-70DF	5 - 12	70 28	85x80x60 34x32x24	340 750	22-27-34- 44-51	40-50-60- 80-100 11-14-16- 22-28	200-220 2900-3200	3	21
TE2.9-90DF	6 - 12	90 36	105x80x60 42x32x24	400 882	27-34- 43-51	50-60- 80-100 14-16- 22-28	200-220 2900-3200	3	24

TE9DF2

HYDRAULIC MULCHER TRINCIATRICE IDRAULICA



WATCH IT IN ACTION
GUARDA IN AZIONE

FEATURES

- Powerful forestry mulcher designed for clearing shrubs and plants with increased cutting capacity.
- Toothed high-performance belts transmission.
- Body without hoods for increased cutting capacity. (available only for extra-EU country)
- **Fixed-tooth rotor** with double-bladed tool and **bite limiter**.
- Inside rotor supports for the protection of the bearings from the impurities.
- Protective belts cover.
- Valves block complete with priority valve for adjusting oil flow, anti-shock valve (pressure relief valve), anti-cavitation and auto-draining.
- Double row ball bearings.
- Cast iron gear motor group 3 "Casappa".

Upon request:

- mounting bracket, custom-made available;
- hoses.

CARATTERISTICHE

- Potente trinciatrice forestale progettata per la pulizia di arbusti e piante, con una notevole capacità di taglio.
- Trasmissione a cinghie trapezoidali dentate.
- Telaio privo di sportello per una maggiore capacità di taglio. (solo per i paesi extra-UE)
- **Rotore a denti fissi** con dente a doppia lama e **limitatore di mordente**.
- Supporti rotore interni per la protezione dei cuscinetti dalle impurità.
- Protezione carter cinghie.
- Blocco valvole comprensivo di valvola prioritaria per regolazione della portata olio, antiurto (valvola di max pressione), anticavitazione e autodrenante.
- Cuscinetti rotore a doppia corona di rulli orientabili.
- Motore gruppo 3 in ghisa "Casappa".

Su richiesta:

- sella di attacco, disponibile su misura;
- fornitura di tubi.

TECHNICAL INFORMATION

CARATTERISTICHE TECNICHE



DF2



SPDF2

Rotor
Rotore

DFD



DFHF22
 Ø max 20 cm



MODELLO MODEL	tons	cm/inch	LxAxH cm/inch	KG kg/lbs	CILINDRATA MOTORE ENGINE DISPLACEMENT	OIL l/min - gpm	bar - psi (min-max)		
TE1.9-70DF2 TE1.9-70SPDF2	5 - 12	70 28	85x65x64 34x25x24	345 760	22-27-34- 44-51	40-50-60- 80-100 11-14-16- 22-28	200-220 2900-3200	3	14
TE2.9-90DF2 TE2.9-90SPDF2	6 - 12	90 36	105x65x64 42x25x24	400 882	27-34- 43-51	50-60- 80-100 14-16- 22-28	200-220 2900-3200	3	18
TE3.9-110DF2 TE3.9-110SPDF2	6 - 12	110 44	124x65x64 49x25x24	470 1036	27-34- 43-51	50-60- 80-100 14-16- 22-28	200-220 2900-3200	3	22

Cast iron hydraulic gear motor range
 Scelta motore idraulico a ingranaggi

ton	5 - 6	6 - 7	7 - 8	8 - 10	10 - 12
CILINDRATA MOTORE ENGINE DISPLACEMENT cc	22	27	34	43	51
l/min gpm	40 11	50 14	60 16	80 22	100 28

HYDRAULIC MULCHER TRINCIATRICE IDRAULICA



WATCH IT IN ACTION
GUARDA IN AZIONE

FEATURES

- Mulcher designed for more power and width when clearing shrubs and plants.
- MSFS forestal rotor with rotating hammers.
- DF forestal rotor with fixed teeth.
- 1 toothed high-performance belt transmission.
- Internally reinforced double-case body.
- Mechanically adjustable hood, fully openable for higher cutting capacity.
- Side skirts adjustable on 3 positions to change the height of the cut.
- Valve block including priority valve for oil flow regulation, shock absorber (max. pressure valve), anti-cavitation and self-draining.
- "Casappa" group 3 cast iron gear motor.
- Accident prevention rubber protections according to EC directives.

Upon request:

- mounting bracket, custom-made available;
- hoses.

CARATTERISTICHE

- Trinciatrice progettata per ottenere più potenza e ampiezza nella pulizia di erba e arbusti.
- Rotore forestale MSFS con mazze a scomparsa.
- Rotore forestale DF a denti fissi.
- Trasmissione monocinghia dentata preallungata.
- Cofanatura interna a doppia cassa con intercapedine.
- Frontalini porta catene di protezione regolabili in altezza.
- Slitte d'appoggio regolabili su 3 posizioni per variare l'altezza di taglio.
- Blocco valvole comprensivo di valvola prioritaria per regolazione della portata olio, antiurto (valvola di max pressione), anticavitazione e autodrenante.
- Motore gruppo 3 in ghisa "Casappa".
- Protezioni antinfortunistiche in gomma a norma CE.

Su richiesta:

- sella di attacco, disponibile su misura;
- fornitura di tubi.

TECHNICAL INFORMATION

CARATTERISTICHE TECNICHE



Rotor Rotore

MSFS



MAZHF19
Ø max 12 cm



MODELLO MODEL	tons	cm/inch	LxAxH cm/inch	KG kg/lbs	CILINDRATA MOTORE ENGINE DISPLACEMENT	OIL l/min - gpm	bar - psi (min-max)		
TE1.13-130MSFS	8 - 12	130 52	145x95x85 58x38x34	650 1433	43 - 51	80-100 22-28	200-220 2900-3200	1 (50mm)	18

Rotor Rotore

DF



DFHF14P
Ø max 25 cm



DFHF15
Ø max 20 cm



MODELLO MODEL	tons	cm/inch	LxAxH cm/inch	KG kg/lbs	CILINDRATA MOTORE ENGINE DISPLACEMENT	OIL l/min - gpm	bar - psi (min-max)		
TE1.13-130DF	10 - 16	130 52	145x95x85 58x38x34	745 1614	43 - 51	80-90 22-28	200-220 2900-3200	1 (50mm)	36

Cast iron hydraulic gear motor range
Scelta motore idraulico a ingranaggi

ton	8 - 10	10 - 12
CILINDRATA MOTORE ENGINE DISPLACEMENT cc	43	51
l/min gpm	80 22	100 28

HYDRAULIC MULCHER TRINCIATRICE IDRAULICA



WATCH IT IN ACTION
GUARDA IN AZIONE

FEATURES

- Mulcher designed for more power and width when clearing shrubs and plants.
- MSFS forestal rotor with rotating hammers.
- DF forestal rotor with fixed teeth.
- 1 toothed high-performance belt transmission.
- Internally reinforced double-case body.
- Protective belts cover.
- Hydraulically adjustable hood.
- Valves block complete with priority valve for adjusting oil flow, anti-shock valve (pressure relief valve) and anti-cavitation.
- Piston motor.
- Accident prevention rubber protections according to EC directives.

Upon request:

- mounting bracket, custom-made available;
- hoses.

CARATTERISTICHE

- Trinciatrice progettata per ottenere più potenza e ampiezza nella pulizia di erba e arbusti.
- Rotore forestale MS con mazze a scomparsa.
- Rotore forestale DF a denti fissi.
- Trasmissione monocinghia dentata preallungata.
- Cofanatura interna a doppia cassa.
- Protezione carter cinghie.
- Cofano anteriore regolabile idraulicamente.
- Blocco valvole comprensivo di valvola prioritaria per regolazione della portata olio, antiurto (valvola di max pressione), anticavitazione.
- Motore a pistoni.
- Protezioni antinfortunistiche in gomma a norma CE.

Su richiesta:

- sella di attacco, disponibile su misura;
- fornitura di tubi.

TECHNICAL INFORMATION

CARATTERISTICHE TECNICHE



Rotor
 Rotore

MS



MAZHF11
 MAZHF13
 Ø max 25 cm



MODELLO MODEL	tons	cm/inch	LxAxH cm/inch A	KG kg/lbs	CILINDRATA MOTORE ENGINE DISPLACEMENT	OIL l/min - gpm	bar - psi (min-max)		
TE1.15-130MS	12 - 25	130 52	160x80x85 63x32x34	920 2028	32 - 64	90-180 25-50	200-250 2900-3600	1 (50 mm)	26
TE2.15-160MS	15 - 25	160 63	190x80x85 75x32x34	1020 2249	32 - 64	90-180 25-50	200-250 2900-3600	1 (50 mm)	32

Rotor
 Rotore

DF



DFHF14P
 Ø max 25 cm



DFHF15
 Ø max 20 cm



MODELLO MODEL	tons	cm/inch	LxAxH cm/inch A	KG kg/lbs	CILINDRATA MOTORE ENGINE DISPLACEMENT	OIL l/min - gpm	bar - psi (min-max)		
TE1.15-130DF	12 - 25	130 52	160x80x85 63x32x34	950 2094	32 - 64	90-180 25-50	200-250 2900-3600	1 (50 mm)	36
TE2.15-160DF	16 - 25	160 63	190x80x85 75x32x34	1050 2315	32 - 64	90-180 25-50	200-250 2900-3600	1 (50 mm)	42

HYDRAULIC MULCHER TRINCIATRICE IDRAULICA



WATCH IT IN ACTION
GUARDA IN AZIONE

FEATURES

- Forestry mulcher designed for maximum power and width in mulching.
- DF forestal rotor with fixed teeth.
- 1 toothed high-performance belt transmission.
- Internally reinforced double-case body.
- Protective belts cover.
- Hydraulically adjustable hood.
- Valves block completely using a priority valve for adjusting the oil flow, anti-shock valve (pressure relief valve), and anti-cavitation.
- Piston motor.
- Accident prevention rubber protections according to EC directives.

Upon request:

- mounting bracket, custom-made available;
- hoses.

CARATTERISTICHE

- Trinciatrice progettata per ottenere più potenza e ampiezza nella pulizia di erba e arbusti.
- Rotore forestale DF a denti fissi.
- Trasmissione monocinghia dentata preallungata.
- Cofanatura interna a doppia cassa.
- Protezione carter cinghie.
- Cofano anteriore regolabile idraulicamente.
- Blocco valvole comprensivo di valvola prioritaria per regolazione della portata olio, antiurto (valvola di max pressione) e anticavitazione.
- Motore a pistoni.
- Protezioni antinfortunistiche in gomma a norma CE.

Su richiesta:

- sella di attacco, disponibile su misura;
- fornitura di tubi.

TECHNICAL INFORMATION

CARATTERISTICHE TECNICHE



Rotor
 Rotore

DF



DFHF14P
 Ø max 30 cm



DFHF15
 Ø max 25 cm



MODELLO MODEL	tons	cm/inch	LxAxH cm/inch	KG kg/lbs	CILINDRATA MOTORE ENGINE DISPLACEMENT	OIL l/min - gpm	bar - psi (min-max)		
TE1.20-130DF	16 - 30	130 52	170x100x90 67x40x36	1050 2315	45 - 60 - 80	100-130- 180 28-35-48	200-350 2900-5100	1 (50 mm)	36
TE2.20-160DF	18 - 30	160 63	200x100x90 79x40x36	1185 2612	45 - 60 - 80	100-130- 180 28-35-48	200-350 2900-5100	1 (50 mm)	42
TE3.20-180DF	20 - 30	180 71	220x100x90 81x40x36	1320 2910	45 - 60 - 80	100-130- 180 28-35-48	200-350 2900-5100	1 (50 mm)	54

Hydraulic piston motor range
 Scelta motore idraulico a pistoni

ton	16 - 18	18 - 25	25 - 30
CILINDRATA MOTORE ENGINE DISPLACEMENT cc	45	60	80
l/min gpm	100 28	130 35	180 48

HYDRAULIC MULCHER TRINCIATRICE IDRAULICA



WATCH IT IN ACTION
GUARDA IN AZIONE

FEATURES

- Compact mulcher, designed for mounting on skid steer.
- Floating self levelling universal hitch.
- K/M helicoidal rotor with austempered hammers and cutting blade interchangeable.
- Hydraulic side shift.
- 4 Toothed high-performance V-belts transmission.
- Internally reinforced double-case body.
- Valves block completely using a priority valve for adjusting the oil flow, anti-shock valve (pressure relief valve), anti-cavitation and self-draining.
- "Casappa" group cast iron gear motor.
- Accident prevention rubber protections according to EC directives.

Upon request:

- mounting bracket, custom-made available;
- hoses.

CARATTERISTICHE

- Trinciatrice compatta, progettata per il montaggio su minipala.
- Attacco oscillante ed autolivellante universale.
- Rotore elicoidale K/M con mazze bonificate e coltelli intercambiabili.
- Traslazione idraulica.
- Trasmissione a 4 cinghie trapezoidali dentate.
- Corpo interno a doppia cassa con intercapedine.
- Blocco valvole comprensivo di valvola prioritaria per regolazione della portata olio, antiurto (valvola di max pressione), anticavitazione e autodrenante.
- Motore a ingranaggi in ghisa "Casappa".
- Protezioni antinfortunistiche in gomma a norma CE.

Su richiesta:

- sella di attacco, disponibile su misura;
- fornitura di tubi.

TECHNICAL INFORMATION

CARATTERISTICHE TECNICHE



Rotor Rotore

K/M



MAZHF6
 Ø max 8 cm



CLTKF3
 Ø max 6 cm



MODELLO MODEL	hp	cm/inch	LxHxW cm/inch	kg/lbs	CILINDRATA MOTORE ENGINE DISPLACEMENT	l/min - gpm	bar - psi (min-max)		
TESK1.5-160K/M	50 - 90	160 63	182x120x110 72x48x44	890 1962	27-34- 43-51	60-70- 90-100 16-22-24-28	200-220 2900-3200	4	18
TESK2.5-180K/M	50 - 90	180 71	202x120x110 80x48x44	930 2050	27-34- 43-51	60-70- 90-100 16-22-24-28	200-220 2900-3200	4	20
TESK3.5-200K/M	50 - 90	200 79	222x120x110 87x48x44	970 2138	27-34- 43-51	60-70- 90-100 16-22-24-28	200-220 2900-3200	4	22

Hydraulic motor range

Scelta motore idraulico a ingranaggi

CILINDRATA MOTORE ENGINE DISPLACEMENT	27	34	43	51
l/min gpm	60 16	70 22	90 24	100 28

TESK10

HYDRAULIC MULCHER TRINCIATRICE IDRAULICA



**WATCH IT IN ACTION
GUARDA IN AZIONE**

FEATURES

- Powerful forestry mulcher, designed for mounting on skid steer loaders.
- Fixed universal hitch.
- DF forestal rotor with fixed teeth.
- Hydraulic translation.
- Mechanically adjustable push bar.
- Manometer for working pressure control.
- Valves block complete with priority valve for adjusting oil flow, anti-shock valve (pressure relief valve) and anti-cavitation.
- Piston motor.
- Accident prevention rubber protections according to EC directives.

Upon request:

- mounting bracket, custom-made available;
- hoses.
- hydraulic push bar.

CARATTERISTICHE

- Potente trinciatrice forestale, progettata per il montaggio su minipala.
- Attacco fisso universale.
- Rotore DF a denti fissi in widia o lama o bonificata.
- Traslazione idraulica.
- Abbattirami meccanico.
- Manometro per controllo pressione di lavoro.
- Blocco valvole comprensivo di valvola prioritaria per regolazione della portata olio, antiurto (valvola di max pressione), anticavitazione.
- Motore a pistoni a cilindrata fissa.
- Protezioni antinfortunistiche in gomma a norma CE.

Su richiesta:

- sella di attacco, disponibile su misura;
- fornitura di tubi;
- abbattirami idraulico.

TECHNICAL INFORMATION

CARATTERISTICHE TECNICHE



Rotor
 Rotore

DF



DFHF14P
 Ø max 30 cm



DFHF15
 Ø max 25 cm



MODELLO MODEL	hp	cm/inch	LxAxH cm/inch	kg/lbs	CILINDRATA MOTORE ENGINE DISPLACEMENT	l/min - gpm	bar - psi (min-max)		
TESK1.10-160DF	70 - 120	160 63	200x100x160 79x40x63	1285 2833	45-60-80	100-130-180 28-35-48	200-350 2900-5100	1	42
TESK2.10-180DF	70 - 120	180 71	220x100x160 87x40x63	1420 3131	45-60-80	100-130-180 28-35-48	200-350 2900-5100	1	54

Hydraulic piston motor range
 Scelta motore idraulico a pistoni

CILINDRATA MOTORE ENGINE DISPLACEMENT	45	60	80
l/min gpm	100 28	130 35	180 48

MOW

MINI MOWER RASAERBA IDRAULICO



WATCH IT IN ACTION
GUARDA IN AZIONE

FEATURES

- Compact hydraulic mower for cutting grass and small shrubs.
- 1 "one-way flow" hydraulic circuit.
- Double row ball bearings rotor.
- Pressure relief and anti-shock valve.
- Self-draining valve available.
- Hydraulic gear motor group 2.

Upon request:

- mounting bracket, custom-made available;
- hoses.

CARATTERISTICHE

- Compatto rasaerba idraulico per la rimozione di erbe infestanti e piccoli arbusti.
- 1 linea idraulica a semplice effetto (martello).
- Rotore a doppio cuscinetto a sfera.
- Valvola di massima e antiurto.
- Disponibile su alcuni modelli valvola autodrenante.
- Motore idraulico a ingranaggi gruppo 2.

Su richiesta:

- sella di attacco, disponibile su misura;
- fornitura di tubi.





TECHNICAL INFORMATION

CARATTERISTICHE TECNICHE

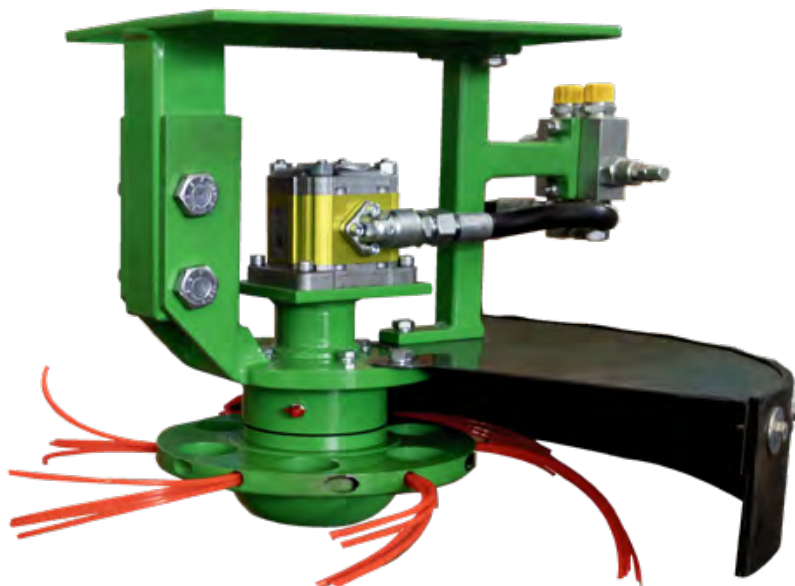

MADE IN ITALY
OMEF GROUP
 FORESTRY EQUIPMENT MANUFACTURER



MODELLO MODEL	 tons	SUPERFICIE DI TAGLIO CUT WIDTH cm/inch	 kg/lbs		VALVOLA VALVE	 l/min - gpm	 bar - psi (min-max)	N° FILI N° WIRES
MOW	1 - 2,5	48 19	47 104	A ingranaggi Gear motor	-	25-35 7-9	150-200 2175-2900	24
MOW1D	1 - 2,5	48 19	47 104	A ingranaggi Gear motor	Autodrenante Auto drain valve	25-35 7-9	150-200 2175-2900	24
MOW2	2 - 5	62 24	50 110	A ingranaggi Gear motor	-	35-45 9-12	150-200 2175-2900	24
MOW2D	2 - 5	62 24	50 110	A ingranaggi Gear motor	Autodrenante Auto drain valve	35-45 9-12	150-200 2175-2900	24

HEDGE TRIMMER TAGLIASIEPI IDRAULICO



WATCH IT IN ACTION
GUARDA IN AZIONE

FEATURES

- Hedge trimmer for precise and fast cutting without residue.
- Cutting system with knives arranged in a star pattern.
- 1 "one-way flow" hydraulic circuit + 1 case drain line.
- Flow regulator.
- 1000/2000 rpm on average.
- Group 1 hydraulic gear motor.

Upon request:

- mounting bracket, custom-made available;
- hoses.

CARATTERISTICHE

- Tagliasiepi per un taglio preciso e veloce senza residui.
- Sistema di taglio con coltelli disposti a stella.
- 1 linea idraulica, a semplice effetto (martello) con drenaggio.
- Regolatore di flusso.
- 1000/2000 giri al minuto in media.
- Motore idraulico a ingranaggi gruppo 1.

Su richiesta:

- sella di attacco, disponibile su misura;
- fornitura di tubi.

TECHNICAL INFORMATION
CARATTERISTICHE TECNICHE









TG1



TG2



MODELLO MODEL	 tons	 cm/inch	 KG kg/lbs			 OIL l/min - gpm	 bar - psi (min-max)	N° COLTELLI N° KNIVES
TG1	2 - 5	120 47	58 127	A ingranaggi Gear motor	3	35-50 9-13	150-200 2175-2900	9
TG2	1,8 - 2,5	80 31	42 92	A ingranaggi Gear motor	2	20-35 5-13	150-200 2175-2900	6

CUTTER BAR BARRA FALCIANTE



FEATURES

- Cutter bar for mowing hedges and branches until 3 cm in diameter.
- Lightweight, easy-to-use machine.
- Available in 3 bar lengths.
- 1 "one-way flow" hydraulic circuit + 1 case drain line.
- Low-drainage 100cc orbital motor.

Upon request:

- mounting bracket, custom-made available;
- hoses.

CARATTERISTICHE







- Barra falciante per lo sfalcio di siepi e rami fino a 3 cm di diametro.
- Macchina leggera di facile utilizzo.
- Disponibile in 3 misure di lunghezza della barra.
- 1 linea idraulica, a semplice effetto (martello) con drenaggio.
- Motore orbitale da 100cc a basso trafilemento.

Su richiesta:

- sella di attacco, disponibile su misura;
- fornitura di tubi.

TECHNICAL INFORMATION
CARATTERISTICHE TECNICHE



	BF1200	BF1500	BF1700
	1 - 5 tons	1 - 5 tons	1 - 5 tons
LUNGHEZZA BARRA WIDTH  cm/inch	120 cm 47"	150 cm 59"	170 cm 67"
 KG	40 Kg 88 lbs	43 Kg 95 lbs	46 Kg 101 lbs
 MAX	30 mm 1"	30 mm 1"	30 mm 1"
 min - max	140 bar 2030 psi	140 bar 2030 psi	140 bar 2030 psi
 min - max	20 - 40 l/min 5 - 10 gpm	20 - 40 l/min 5 - 10 gpm	20 - 40 l/min 5 - 10 gpm

PRUNING SHEAR BAR BARRA TRONCARAMI



FEATURES

- Pruning shear bar made perfect for maintaining green areas and pruning tall trees.
- High-strength steel comb blades.
- Mechanical tilt adjustment.
- 3/4" hydraulic hoses with 2.0 m length.
- 3/4" flow regulating valve (max 100 litres).
- Adapter plate four mounting bracket.
- Safety guards to CE standards.

Upon request:

- mounting bracket, custom-made available;
- hoses.

CARATTERISTICHE

- Barra troncarami realizzata per la manutenzione del verde e la potatura di piante ad alto fusto.
- Lamine a pettine in acciaio ad alta resistenza.
- Regolazione meccanica dell'inclinazione.
- Tubi idraulici da 3/4" con lunghezza = 2.0 mt.
- Valvola regolatrice di portata da 3/4" (max 100 lt).
- Contropiastra per fissaggio sella.
- Protezioni antinfortunistiche a norme CE.





Su richiesta:

- sella di attacco, disponibile su misura;
- fornitura di tubi.

TECHNICAL INFORMATION

CARATTERISTICHE TECNICHE



	TRI1600	TRI1900	TRI2200
	4 - 10 tons	4 - 10 tons	4 - 10 tons
LUNGHEZZA BARRA WIDTH cm/inch 	160 cm 63"	190 cm 75"	220 cm 87"
	240 Kg 529 lbs	265 Kg 584 lbs	290 Kg 639 lbs
 MAX	100 mm 4"	100 mm 4"	100 mm 4"
 min - max	250 bar 3700 psi	250 bar 3700 psi	250 bar 3700 psi
 min - max	60 l/min 16 gpm	60 l/min 16 gpm	60 l/min 16 gpm
GIRI REV	85 min	85 min	85 min

CUTTING DISC BAR BARRA DI TAGLIO A DISCHI

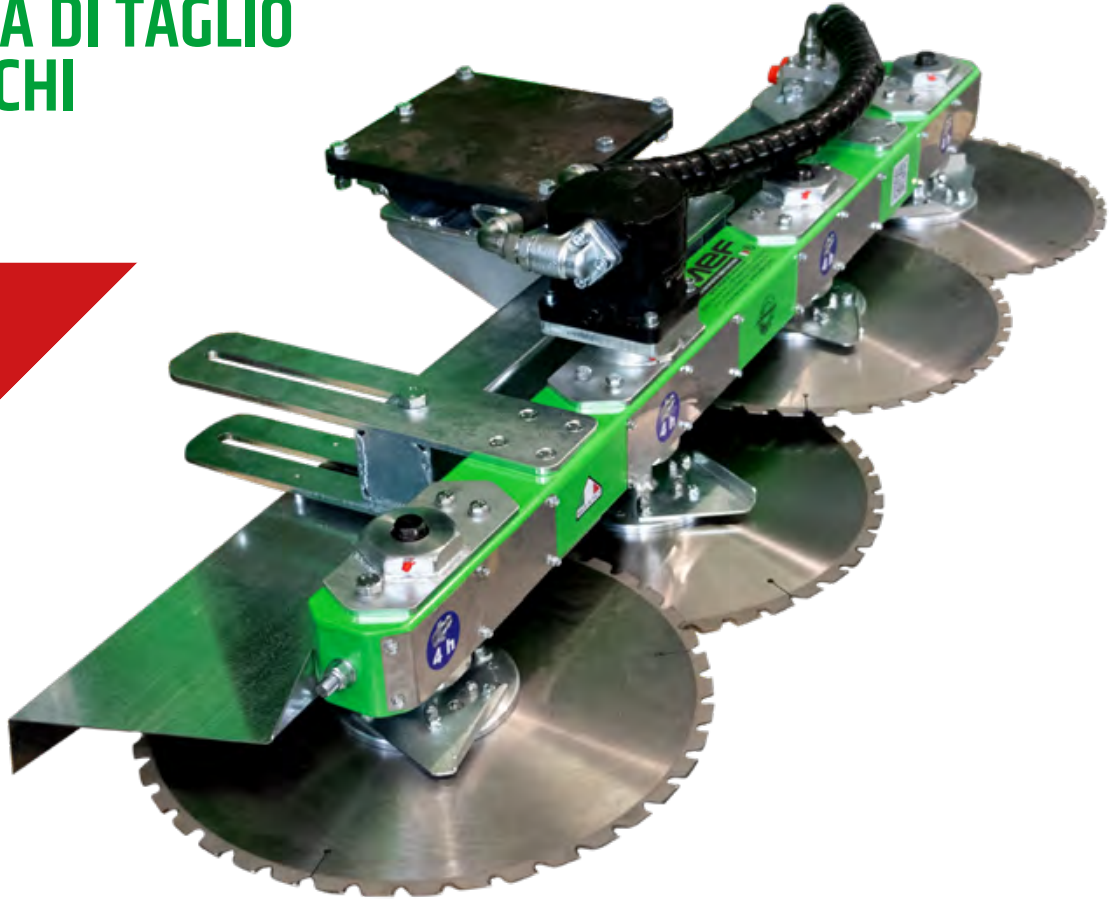

FEATURES

- Cutting disc bar, for forestry pruning, with discs.
- Robust steel body with housing for 2 to 4 discs.
- 1 "one-way flow" hydraulic circuit.
- Valve block including priority valve for oil flow regulation, shock absorber (max. pressure valve), anti-cavitation and self-draining.
- Hydraulic motor group 3 "Casappa".
- Discs covers for transport.

Upon request:

- mounting bracket, custom-made available;
- hoses.

CARATTERISTICHE

- Barra di taglio, per potature forestali, a dischi.
- Robusta struttura in acciaio che monta da 2 a 4 dischi.
- 1 linea idraulica a semplice effetto (martello).
- Blocco valvole comprensivo di valvola prioritaria per regolazione della portata olio, antiurto (valvola di max pressione), anticavitazione e autodrenante.
- Motore idraulico gruppo 3 "Casappa".
- Cover di protezione delle lame per il trasporto.

Su richiesta:

- sella di attacco, disponibile su misura;
- fornitura di tubi.

TECHNICAL INFORMATION

CARATTERISTICHE TECNICHE



	BTD2	BTD3	BTD4
	3 - 10 tons	3 - 10 tons	3 - 10 tons
LUNGHEZZA BARRA WIDTH cm/inch	122 cm 48"	156 cm 62"	204 cm 80"
	73 Kg 161 lbs	107 Kg 263 lbs	144 Kg 317 lbs
 MAX	100-150 mm 4"	100-150 mm 4"	100-150 mm 4"
 min - max	150 bar 2200 psi	150 bar 2200 psi	150 bar 2200 psi
 min - max	40 - 150 l/min 11 - 40 gpm	40 - 150 l/min 11 - 40 gpm	40 - 150 l/min 11 - 40 gpm
RPM MAX	3000	3000	3000
DIAMETRO DISCO DISC DIAMETER	60 cm 23,6"	60 cm 23,6"	60 cm 23,6"
N° DISCHI N° DISCS	2	3	4

HYDRAULIC DRILL TRIVELLA IDRAULICA



FEATURES

- Hydraulic earth drill.
- Structure with double swing mounting adapter.
- 1 "one-way flow" hydraulic circuit + 1 case drain line.
- Operable in both directions of rotation.
- Available with two different types of bits:
 - for standard soils;
 - for rocky terrain.

Upon request:

- mounting bracket, custom-made available;
- hoses;
- extension.

CARATTERISTICHE

- Punta trivella idraulica.
- Struttura con sella a doppia oscillazione.
- 1 linea idraulica a semplice effetto (martello) con drenaggio.
- Azionabile in senso orario e antiorario.
- Disponibile con due diverse tipologie di punte:
 - per terreni standard;
 - per terreni rocciosi.

Su richiesta:

- sella di attacco, disponibile su misura;
- fornitura di tubi;
- prolunga.

TECHNICAL INFORMATION

CARATTERISTICHE TECNICHE



TRV

	TRV10	TRV20	TRV30	TRV40	TRV50	TRV60
	1,2 - 2,5 tons	2,2 - 4 tons	4 - 10 tons	10 - 20 tons	10 - 20 tons	15 - 30 tons
	70 Kg 154 lbs	118 Kg 260 lbs	138 Kg 304 lbs	124 Kg 273 lbs	228 Kg 503 lbs	260 Kg 573 lbs
GIRI/LITRO REVS/LITRE	2,35	1,5	0,8	0,6-0,75	0,56	0,21
 min - max	MAX 200 bar 2900,75 psi	MAX 200 bar 2900,75 psi	MAX 200 bar 2900,75 psi	MAX 200 bar 2900,75 psi	MAX 200 bar 2900,75 psi	MAX 200 bar 2900,75 psi
 min - max	50 l/min 13 gpm	50 l/min 13 gpm	50 l/min 13 gpm	150 l/min 40 gpm	200 l/min 53 gpm	200 l/min 53 gpm
	1520 Nm 1120 ft lbf	2480 Nm 1830 ft lbf	6440 Nm 4750 ft lbf	11560 Nm 8530 ft lbf	20000 Nm 14750 ft lbf	20000 Nm 14750 ft lbf
	50 mm	50 mm	50 mm	70 mm	70 mm	70 mm
150x1000mm	terreno misto/roccia terrain normal/rocky	terreno misto/roccia terrain normal/rocky	terreno misto/roccia terrain normal/rocky	terreno misto/roccia terrain normal/rocky	terreno misto/roccia terrain normal/rocky	terreno misto/roccia terrain normal/rocky
200x1000mm	terreno misto/roccia terrain normal/rocky	terreno misto/roccia terrain normal/rocky	terreno misto/roccia terrain normal/rocky	terreno misto/roccia terrain normal/rocky	terreno misto/roccia terrain normal/rocky	terreno misto/roccia terrain normal/rocky
250x1000mm	terreno misto/roccia terrain normal/rocky	terreno misto/roccia terrain normal/rocky	terreno misto/roccia terrain normal/rocky	terreno misto/roccia terrain normal/rocky	terreno misto/roccia terrain normal/rocky	terreno misto/roccia terrain normal/rocky
300x1000mm	terreno misto/roccia terrain normal/rocky	terreno misto/roccia terrain normal/rocky	terreno misto/roccia terrain normal/rocky	terreno misto/roccia terrain normal/rocky	terreno misto/roccia terrain normal/rocky	terreno misto/roccia terrain normal/rocky
350x1000mm	terreno misto/roccia terrain normal/rocky	terreno misto/roccia terrain normal/rocky	terreno misto/roccia terrain normal/rocky	terreno misto/roccia terrain normal/rocky	terreno misto/roccia terrain normal/rocky	terreno misto/roccia terrain normal/rocky
400x1000mm	terreno misto/roccia terrain normal/rocky	terreno misto/roccia terrain normal/rocky	terreno misto/roccia terrain normal/rocky	terreno misto/roccia terrain normal/rocky	terreno misto/roccia terrain normal/rocky	terreno misto/roccia terrain normal/rocky
450x1000mm	terreno misto/roccia terrain normal/rocky	terreno misto/roccia terrain normal/rocky	terreno misto/roccia terrain normal/rocky	terreno misto/roccia terrain normal/rocky	terreno misto/roccia terrain normal/rocky	terreno misto/roccia terrain normal/rocky
500x1000mm	terreno misto/roccia terrain normal/rocky	terreno misto/roccia terrain normal/rocky	terreno misto/roccia terrain normal/rocky	terreno misto/roccia terrain normal/rocky	terreno misto/roccia terrain normal/rocky	terreno misto/roccia terrain normal/rocky

PUNTE - DRILL

PUNTA TERRENO MISTO
 NORMAIL TERRAIN DRILL



PUNTA TERRENO ROCCIA
 ROCKY TERRAIN DRILL



HYDRAULIC COMPACTOR COMPATTATORE



FEATURES

- Hydraulic plate compactor.
- Developed for the road sector, to prepare base for paving, as a pile plant or for the agricultural sector.
- 1 "one-way flow" hydraulic circuit self-draining.
- Pressure relief valve.
- Gear motor.
- Shock-absorbing rubber buffers.

Upon request:

- mounting bracket, custom-made available;
- hoses;
- pile-driver plate.

CARATTERISTICHE

- Compattatore idraulico a piastra vibrante.
- Sviluppato per il comparto stradale, per preparare base per pavimentazione, come pianta pali o per il settore agricolo.
- 1 linea idraulica a semplice effetto (martello) autodrenante.
- Valvola di massima pressione.
- Motore a ingranaggi.
- Tamponi in gomma ammortizzante.

Su richiesta:

- sella di attacco, disponibile su misura;
- fornitura di tubi;
- piastra battipali.

TECHNICAL INFORMATION
CARATTERISTICHE TECNICHE



CPT180



2 - 5 tons

170 Kg
375 lbs

100 - 120 bar
1450 - 1740 psi

12 - 20 l/min
4 - 5 gpm

1200 - 2200

18 tons

CPT425



5 - 9 tons

430 Kg
950 lbs

90 - 130 bar
1300 - 1885 psi

30 - 50 l/min
8 - 13 gpm

1000 - 1500

50 tons

CPT910



12 - 20 tons

900 Kg
1984 lbs

100 - 170 bar
1450 - 2465 psi

50 - 100 l/min
13 - 26 gpm

1000 - 1700

110 tons



min - max



min - max

GIRI AL MINUTO
ROUND/MIN

FORZA AL SUOLO
FORCE TO THE
GROUND

SNOW BLOWER FRESA DA NEVE



FEATURES

- Designed to remove snow from confined spaces that cannot be reached by conventional clearing vehicles.
- 3 hydraulic circuits.
- Adjustable glides with a working height of 700 mm.
- Hydraulic gear motor.
- Replaceable blades.

Upon request:

- mounting bracket, custom-made available;
- hoses.

CARATTERISTICHE

- Progettata per rimuovere la neve da spazi ridotti, non raggiungibili dai classici mezzi di sgombero.
- 3 linee idrauliche.
- Slitte regolabili con un altezza di lavoro di 700 mm.
- Motore idraulico a ingranaggi.
- Lame sostituibili.

Su richiesta:

- sella di attacco, disponibile su misura;
- fornitura di tubi.

TECHNICAL INFORMATION
CARATTERISTICHE TECNICHE

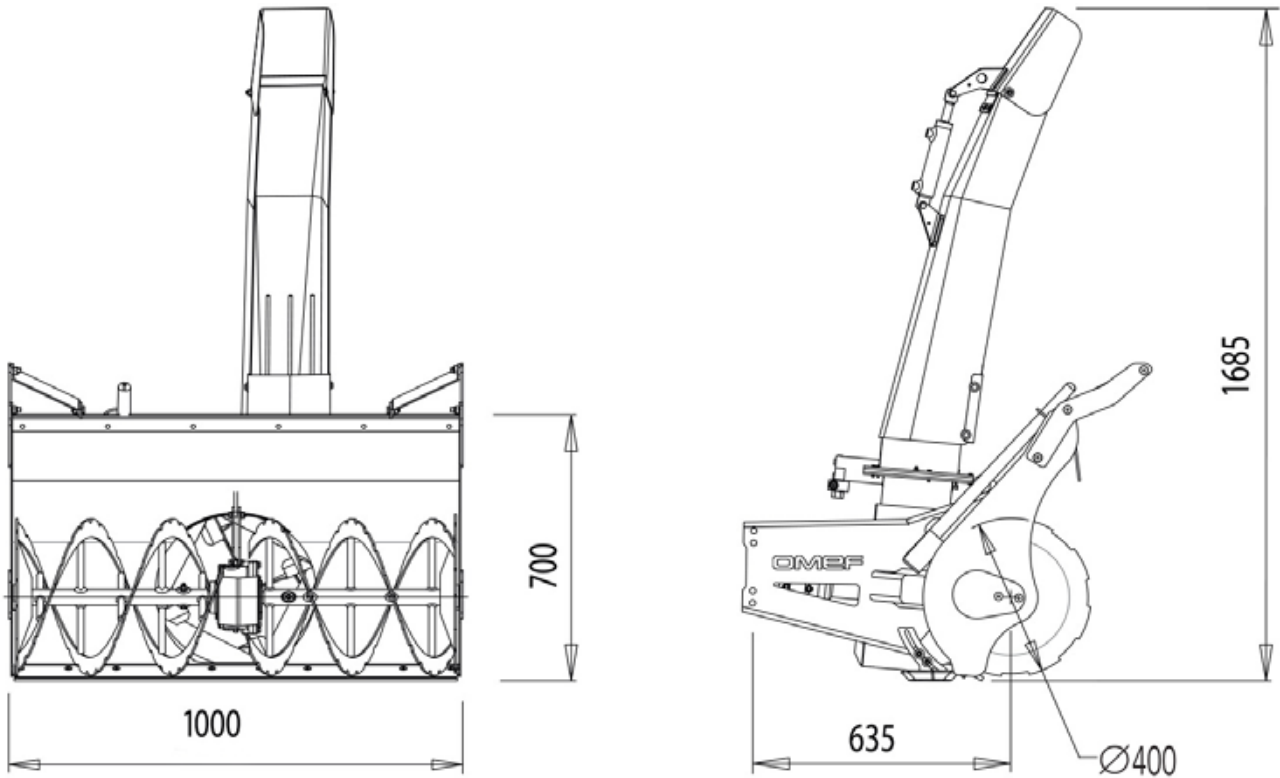

FN1000

 	3 - 6 tons	 min - max LARGHEZZA LAVORO/ CLEARANCE WIDTH	30 - 60 l/m 8 - 16 gpm
	185 kg 408 lbs		1000 mm 39"